

Artos Tooling

Mechtrix Single "V" Series Stripping Blades

Used In These Machines

Artos

CS-6
CS-9
CS-10
CS-11
CS-15
CS-18
CS-20
CS-20
TA-20
CS-21
CS-23
CS-27
CS-30
CS-33
S-1

Amp

CLS (all)

Kut-Rite

MCS (all)
BTS (all)

The Mechtrix Single "V" Stripping Blades are used when processing one wire at a time on machines manufactured by the Artos Engineering Company. "V" Series Stripping Blades are made to precision standards from a specially selected tool steel to insure optimum performance and blade life and are produced using state-of-the-art manufacturing techniques. "V" Series Stripping Blades have the Mechtrix patented feature of a cutting form which includes a perfectly formed cutting radius. The perfectly formed cutting radius insures optimum cutting of the insulation while the entry angle improves the blade's "gathering" characteristics, thus eliminating the need for wire guides.

"V" Series Stripping Blades are a "V-type" blade and offer several advantages over "die-type" blades. These advantages include adjustability over a range of conductor diameters (rather than being sized for only one conductor diameter as is a die-type blade), superior cutting and gathering ability, and longer blade life. Please contact Mechtrix for assistance in selecting the appropriate size blade for your particular application.

Single "V" Tooling Setup

No.	Part Description	Qty.	No.	Part Description	Qty.
1	"V" Stripping Blade-Short	2	5	Artos 4" Toolholder	2
2	"V" Stripping Blade-Long	2	6	Mechtrix Endscrew/Washer Assembly	4
3	Cut-off Blade	2	7		
4	Spacers	-	8		

Mechtrix "V" Series Stripping Blades are covered by U.S. Pat. 4,630,406



Mechtrix Corporation • W147 N9461 Held Drive • Menomonee Falls, WI 53051
Tel (262) 255-6555 • Fax (262) 255-2628 • www.mechtrix.com

Artos Tooling

Mechtrix Single "V" Series Stripping Blades



Mechtrix Single "V" Series Stripping Blades

Mechtrix Description	Mechtrix Part Number	Blade Form Diameter		OEM Part Number
		(in)	(mm)	
V-012S Stripping Blade-Short	12753	0.01200	0.30	86777-21
V-012L Stripping Blade-Long	12752			86777-22
V-022S Stripping Blade-Short	12755	0.02200	0.56	86777-19
V-022L Stripping Blade-Long	12754			86777-20
V-034S Stripping Blade-Short (replaces V-32)	14218	0.03400	0.86	86777-1
V-034L Stripping Blade-Long (replaces V-32L)	14219			86777-2
V-042S Stripping Blade-Short	12757	0.04200	1.07	86777-3
V-042L Stripping Blade-Long	12756			86777-4
V-052S Stripping Blade-Short	12759	0.05200	1.32	86777-5
V-052L Stripping Blade-Long	12758			86777-6
V-062S Stripping Blade-Short (replaces V-16)	14222	0.06200	1.57	86777-7
V-062L Stripping Blade-Long (replaces V-16L)	14223			86777-8
V-076S Stripping Blade-Short	12761	0.07600	1.93	86777-9
V-076L Stripping Blade-Long	12760			86777-10
V-096S Stripping Blade-Short (replaces V-332)	14220	0.09600	2.44	86777-11
V-096L Stripping Blade-Long (replaces V-332L)	14221			86777-12
V-112S Stripping Blade-Short	12725	0.11200	2.84	86777-13
V-112L Stripping Blade-Long	12724			86777-14
V-125S Stripping Blade-Short (replaces V-8)	00228	0.12500	3.18	-
V-125L Stripping Blade-Long (replaces V-8L)	00218			-
V-156A Stripping Blade-Short (replaces V-532A)	00230	0.15625	3.97	-
V-156L Stripping Blade-Long (replaces V-532L)	00219			-
V-172A Stripping Blade-Short	15925	0.17200	4.37	86777-15
V-172L Stripping Blade-Long	12762			86777-16
V-187A Stripping Blade-Short (replaces V-316A)	00231	0.18750	4.76	-
V-187L Stripping Blade-Long (replaces V-316L)	00220			-
V-222A Stripping Blade-Short (replaces V-732A)	14224	0.22200	5.64	86777-17
V-222L Stripping Blade-Long (replaces V-732L)	14225			86777-18
V-250A Stripping Blade-Short (replaces V-4A)	00232	0.25000	6.35	-
V-250L Stripping Blade-Long (replaces V-4L)	00221			-

Mechtrix Single "V" Series Cut-Off Blades

Mechtrix Description	Mechtrix Part Number	Blade Form Diameter		OEM Part Number
		(in)	(mm)	
MCL Cut-off Blade	01393	-	-	C-2681-09
CL Cut-off Blade	00022	-	-	C-2681-02
CLA Cut-off Blade	00024	-	-	C-2681-01

A set of "V" Series Blades consists of two (2) "V" Strip Blades-Short, two (2) "V" Strip Blades-Long and two (2) Cut-off Blades.

Mechtrix "V" Series Stripping Blades are covered by U.S. Pat. 4,630,406



Mechtrix Corporation • W147 N9461 Held Drive • Menomonee Falls, WI 53051
Tel (262) 255-6555 • Fax (262) 255-2628 • www.mechtrix.com

Artos Tooling

“WV” Series Stripping Blades

Used In These Machines

- Artos**
 CS-6
 CS-9
 CS-10
 CS-11
 CS-23
 CS-27

“WV” Series Blades are used to strip round wires with conductor diameters which range between 0.230" and 0.620" and have an outside diameter of 0.700" or less. They are specifically suited for use in Artos CS-6, CS-9, CS-10, CS-11, CS-23 and CS-27 Machines. All “WV” Series Blades feature perfect cutting form radii and are made from specially selected tool steels to insure optimum blade life and performance. “State-of-the-art” manufacturing techniques are used to insure strict dimensional standards are achieved and maintained. “WV” Series Blades are offered in a closely incremented progression of blade sizes to insure the blade hole size closely conforms to the requirements of the wire being processed. As with all “V” Type Stripping Blades, the “WV” Blades are adjustable and offer the excellent cutting properties intrinsic to the “V” type design.

Please contact Mechtrix for assistance in selecting the appropriate size blade for your particular application.

- Kut-Rite**
 MCS (all)
 BTS (all)



Mechtrix "WV" Series Stripping Blades

Mechtrix Description	Mechtrix Part Number	Blade Form Diameter		OEM Part Number
		(in)	(mm)	
WV-281A Stripping Blade-Short (WV-932A)	00960	0.28125	7.14	-
WV-281L Stripping Blade-Long (WV-932L)	00959			-
WV-312A Stripping Blade-Short (WV-516A)	00963	0.31250	7.94	-
WV-312L Stripping Blade-Long (WV-516L)	00962			-
WV-343A Stripping Blade-Short (WV-1132A)	00966	0.34375	8.73	-
WV-343L Stripping Blade-Long (WV-1132L)	00965			-
WV-375A Stripping Blade-Short (WV-38A)	00969	0.37500	9.53	-
WV-375L Stripping Blade-Long (WV-38L)	00968			-
WV-406A Stripping Blade-Short (WV-1332A)	01362	0.40625	10.32	-
WV-406L Stripping Blade-Long (WV-1332L)	01361			-
WV-437A Stripping Blade-Short (WV-716A)	01365	0.43750	11.11	-
WV-437L Stripping Blade-Long (WV-716L)	01364			-
WV-468A Stripping Blade-Short (WV-1532A)	02375	0.46875	11.91	-
WV-468L Stripping Blade-Long (WV-1532L)	02374			-
WV-500A Stripping Blade-Short (WV-12A)	02371	0.50000	12.70	-
WV-500L Stripping Blade-Long (WV-12L)	02370			-
WV-531A Stripping Blade-Short (WV-1732A)	03564	0.53125	13.49	-
WV-531L Stripping Blade-Long (WV-1732L)	03565			-
WV-562A Stripping Blade-Short (WV-916A)	03566	0.56250	14.29	-
WV-562L Stripping Blade-Long (WV-916L)	03567			-
WV-593A Stripping Blade-Short (WV-1932A)	02311	0.59375	15.08	-
WV-593L Stripping Blade-Long (WV-1932L)	02310			-
WV-625A Stripping Blade-Short (WV-58A)	14569	0.62500	15.88	-
WV-625L Stripping Blade-Long (WV-58L)	14570			-

Cut Off Blades

Mechtrix Description	Mechtrix Part Number	Blade Form Diameter		OEM Part Number
		(in)	(mm)	
WCLA	02319	-	-	-

A set of “WV” Series Blades consists of two (2) “WV” Strip Blades-Short, two (2) “WV” Strip Blades-Long and two (2) “WCLA” Cut-off Blades.

Mechtrix “WV” Stripping Blades are covered by U.S. Pat. 4,630,406



Mechtrix Corporation • W147 N9461 Held Drive • Menomonee Falls, WI 53051
 Tel (262) 255-6555 • Fax (262) 255-2628 • www.mechtrix.com

Artos Tooling

Mechtrix "M" Series Stripping Blades

Used In These Machines

Artos

- CS-6
- CS-9
- CS-10
- CS-11
- CS-15
- CS-18
- CS-20
- TA-20
- CS-21
- CS-23
- CS-27
- CS-30
- CS-33
- S-1

Amp

- CLS (all)

Kut-Rite

- MCS (all)
- BTS (all)

"M" Series Stripping Blades are designated "M" as they incorporate a Mechtrix patented blade design which offers a compound entry angle into the cutting portion of the blade. This design feature, while continuing to offer the advantages of a "V" type design (excellent wire gathering and adjustability) facilitates a higher degree of circumferential cut around a wire's conductor.

"M" Series Blades are available in a wide range of closely incremented radii sizes and offer improved performance when processing wire which require a cutting configuration which closely matches the wire's conductor diameter. This feature is of greatest benefit when processing insulations which are either very soft (i.e., Neoprene or Silicon), very hard and thin (i.e., Teflon, etc.), or just very thin. "M" Series Blades will improve difficult processing problems and have, in many cases, facilitated the processing of wires which had previously been impossible to strip automatically.

Please contact Mechtrix for assistance in selecting the appropriate size blade for your particular application.

"M" Series Tooling Setup

No.	Part Description	Qty.	No.	Part Description	Qty.
1	"M" Stripping Blade-Short	2	5	Artos 4" Toolholder	2
2	"M" Stripping Blade-Long	2	6	Mechtrix Endscrew/Washer Assembly	4
3	Cut-off Blade	2	7		
4	Spacers	-	8		

Artos Tooling

Mechtrix "M" Series Stripping Blades



"M" Series Stripping Blades

Mechtrix Description	Mechtrix Part Number	Blade Form Diameter		OEM Part Number
		(in)	(mm)	
M-016 Stripping Blade-Short	00343	0.01600	0.41	-
M-016L Stripping Blade-Long	00342			-
M-020 Stripping Blade-Short	01064	0.02000	0.51	-
M-020L Stripping Blade-Long	01063			-
M-024 Stripping Blade-Short	00269	0.02400	0.61	-
M-024L Stripping Blade-Long	00268			-
M-028 Stripping Blade-Short	01066	0.02800	0.71	-
M-028L Stripping Blade-Long	01065			-
M-032 Stripping Blade-Short	00410	0.03200	0.81	-
M-032L Stripping Blade-Long	00409			-
M-040 Stripping Blade-Short	01068	0.04000	1.02	-
M-040L Stripping Blade-Long	01067			-
M-048 Stripping Blade-Short	00413	0.04800	1.22	-
M-048L Stripping Blade-Long	00412			-
M-054 Stripping Blade-Short	01071	0.05400	1.37	-
M-054L Stripping Blade-Long	01070			-
M-062 Stripping Blade-Short	00416	0.06200	1.57	-
M-062L Stripping Blade-Long	00415			-
M-070 Stripping Blade-Short	01074	0.07000	1.78	-
M-070L Stripping Blade-Long	01073			-
M-078 Stripping Blade-Short	01144	0.07800	1.98	-
M-078L Stripping Blade-Long	01143			-
M-086 Stripping Blade-Short	01331	0.08600	2.18	-
M-086L Stripping Blade-Long	01330			-
M-094 Stripping Blade-Short	01334	0.09400	2.39	-
M-094L Stripping Blade-Long	01333			-
M-102 Stripping Blade-Short	01306	0.10200	2.59	-
M-102L Stripping Blade-Long	01305			-
M-110 Stripping Blade-Short	01482	0.11000	2.79	-
M-110L Stripping Blade-Long	01481			-
M-118 Stripping Blade-Short	01485	0.11800	3.00	-
M-118L Stripping Blade-Long	01484			-
M-126 Stripping Blade-Short	01488	0.12600	3.20	-
M-126L Stripping Blade-Long	01487			-
M-134 Stripping Blade-Short	01491	0.13400	3.40	-
M-134L Stripping Blade-Long	01490			-
M-142 Stripping Blade-Short	01494	0.14200	3.61	-
M-142L Stripping Blade-Long	01493			-
M-150 Stripping Blade-Short	01497	0.15000	3.81	-
M-150L Stripping Blade-Long	01496			-
M-158 Stripping Blade-Short	01500	0.15800	4.01	-
M-158L Stripping Blade-Long	01499			-

A set of "M" Series Blades consists of two (2) "M" Strip Blades-Short, two (2) "M" Strip Blades-Long and two (2) Cut-off Blades.

Mechtrix "M" Series Stripping Blades are covered by U.S. Pat. 4,630,406 and U.S. Pat. 4,577,405



Mechtrix Corporation • W147 N9461 Held Drive • Menomonee Falls, WI 53051
Tel (262) 255-6555 • Fax (262) 255-2628 • www.mechtrix.com

Artos Tooling

Mechtrix “ID”, “IDQ” and “WID” Series Tooling

Used In These Machines

Artos

CS-6
CS-9
CS-10
CS-11
CS-15
CS-18
CS-20
TA-20
CS-21
CS-23
CS-27
CS-30
CS-33
S-1

Amp

CLS (all)

Kut-Rite

MCS (all)
BTS (all)

Mechtrix complete line of “Interlocking Die-Type” Stripping Blades are a truly new concept in wire stripping tooling

The unique, modular concept utilizes components which interlock to achieve the precise formation and alignment of two concentric holes—a stripping hole for the conductor and a guiding hole for the outer insulation. The stripping hole is formed by the “ID” Stripping Blades, the guiding hole is formed by the “IDG” Guide and the “IDS” Stop. These components interlock to form a rigid, single unit as they are closed on a wire.

“ID” Series Blades offer several features which distinguish them from the traditional “die type” designs. Specifically, the “ID” Series Blades

Create perfectly round cutting forms with a sharp edge around the entire periphery of the cutting area. This feature facilitates excellent cutting of the insulation around 360 degrees of the conductor and eliminates the “pinching” effect which is inherent to other “die-type” designs.

Feature an interlocking “IDG” Guide and “IDS” Stop which are sized to precisely define and equalize the penetration depth of the blade cutting edges into the insulation.

Achieve significantly improved gathering of the wire into the blade cutting form as a result of the unique “IDG” Guide design.

Can achieve a minimum 0.125” strip with standard cut-off tooling. Shorter strip lengths are achieved using special cut-off blades.

Offer the flexibility to use “IDG” Guides and “IDS” Stops with other “ID” Stripping Blades sizes, thus minimizing the long term cost of perishable tooling.

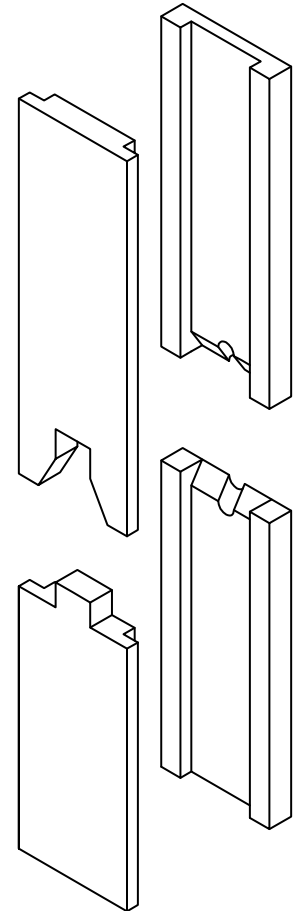

“IDQ” Interlocking Die-Type Stripping Blades are designed to be used with wires having a Measured Insulation Diameter (D) of less than 0.040” (1.02mm).

“ID” Interlocking Die-Type Stripping Blades are designed to be used with wires having a Measured Insulation Diameter (D) between 0.040” and 0.400” (1.02mm - 10.16mm).

“WID” Interlocking Die-Type Stripping Blades are designed to be used with wires having a Measured Insulation Diameter (D) between 0.401” and 0.625” (10.17mm - 15.88mm).

Artos Tooling

Mechtrix "ID" Series Stripping Blades

Used In These Machines

Artos

- CS-6
- CS-9
- CS-10
- CS-11
- CS-15
- CS-18
- CS-20
- TA-20
- CS-21
- CS-23
- CS-27
- CS-30
- CS-33
- S-1

"IDQ" Series Interlocking Die-Type Stripping Blades, Guides and Stops

For wires with an Insulation Diameter (D) of up to 0.040" (1.02mm).

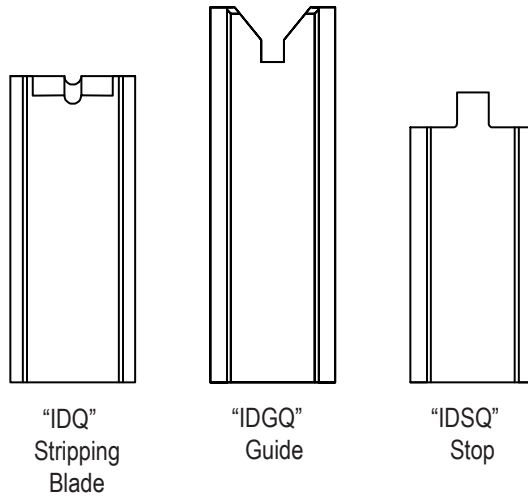

Amp

- CLS (all)

Kut-Rite

- MCS (all)
- BTS (all)

"ID" Series Interlocking Die-Type Stripping Blades, Guides and Stops

For wires with an Insulation Diameter (D) of 0.040 - 0.400" (1.02 - 10.16mm).

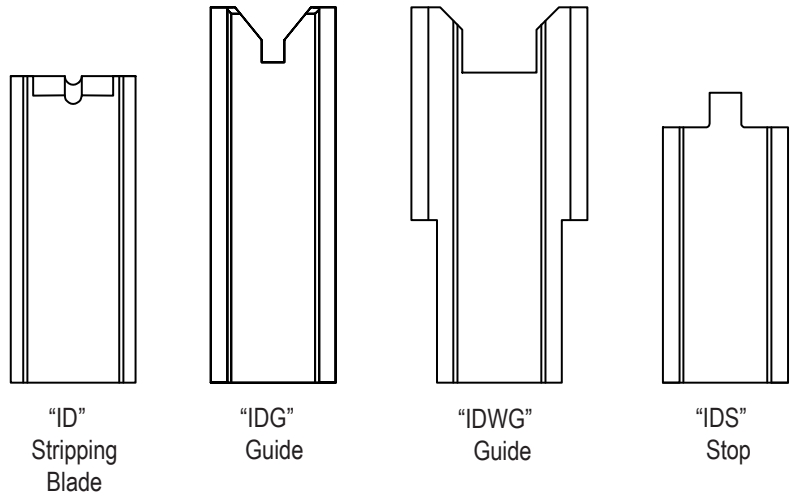

"WID" Series Interlocking Die-Type Stripping Blades, Guides and Stops

For wires with an Insulation Diameter (D) of 0.401 - 0.625" (10.17 - 15.88mm).

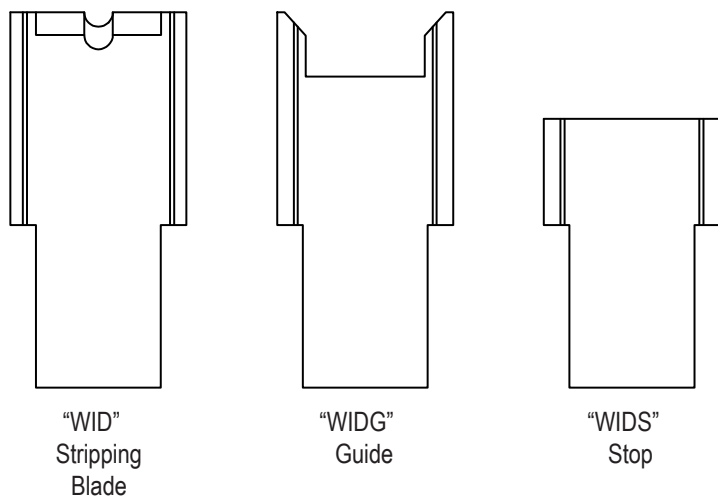

Artos Tooling

Mechtrix "ID" Series Stripping Blades

Used In These Machines

Artos

- CS-6
- CS-9
- CS-10
- CS-11
- CS-15
- CS-18
- CS-20
- TA-20
- CS-21
- CS-23
- CS-27
- CS-30
- CS-33
- S-1

Amp

- CLS (all)

Kut-Rite

- MCS (all)
- BTS (all)

Mechtrix "ID" Series Stripping Blades are designed for use in most wire processing machines made by Artos Engineering Company. "ID" Interlocking Die-Type Stripping Blades are designed to be used with wires having a Measured Insulation Diameter (D) between 0.040" and 0.400" (1.02mm - 10.16mm). "ID" Series Stripping Blades are made to precision standards from a specially selected tool steel to insure optimum performance and blade life and are produced using state-of-the-art manufacturing techniques. The state-of-the-art manufacturing techniques are combined with patented Mechtrix technology to produce perfect stripping form radii.

"ID" Series "Die-type" Stripping Blades incorporate several important features. First, because the blades close against each other, the closing dimension of the machine cutterhead is assured as is the formation of the optimum blade hole size for the blade being used. Second, set-up time is minimized because no adjustments (to the machine cutterhead) are required when changing blade sizes. Though "ID" Series Blades are not adjustable, their non-adjustable feature is of significant benefit when processing thin wall insulations, very hard insulations (Teflon, etc.) or wire with multiple layer insulations (fusible link, etc.).

"ID" Series Blades are available in blade hole size increments of 0.1mm (.004") and require the use of "IDG" Wire Guides and "IDS" Insulation Stops. Please contact Mechtrix for assistance in selecting the appropriate size blade for your particular application.

"ID" Series Tooling Setup

No.	Part Description	Qty.	No.	Part Description	Qty.
1	"ID" Stripping Blade-Short	2	5	Artos 4" Toolholder	2
2	"ID" Stripping Blade-Long	2	6	Mechtrix Endscrew/Washer Assembly	4
3	Cut-off Blade	2	7	"IDG" Wire Guide-Long	2
4	Spacers	-	8	"IDS" Stop-Short	2

Artos Tooling

Mechtrix Stripping Blades for 2-Conductor Cables

Used In These Machines

Artos

CS-6
CS-9
CS-10
CS-11
CS-15
CS-18
CS-20
TA-20
CS-21
CS-23
CS-26
CS-27
CS-29
CS-30
CS-33
S-1

Kut-Rite

MCS (all)
BTS (all)

Mechtrix manufactures both "V" and "Die-Type" Stripping Blades to process flat electrical wire with two (2) parallel conductors (SPT-2, HPN, speaker wire etc.) or for processing two (2) separate wires simultaneously in most wire processing machines manufactured by the Artos Engineering Company.

Mechtrix 2-Conductor stripping blades are made to precision standards from a specially selected tool steel to insure optimum performance and blade life and are produced using state-of-the-art manufacturing techniques. Like all Mechtrix Blades these blades are computer designed to insure that the many intersecting angles and radii are optimally suited to the wire being processed. Our precision manufacturing techniques combined with patented cutting form geometry create tools that are optimally suited to our customers specific wire and unique processing requirements. 2-Conductor stripping blades also require the use of "straight cut" cut-off blades for process optimization.

Since many 2-Conductor wires require the ends to be cut and stripped to different lengths, Mechtrix also offers special 2-Conductor stripping blades to accommodate "stagger strip" requirements. (Please note that stagger strip configurations require the use of a pre-slitler).

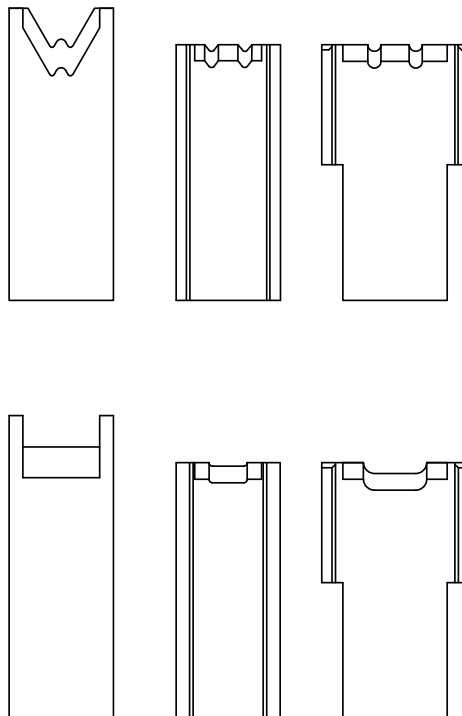

Mechtrix also offers "Jacket" Stripping Blades for removing the oval shaped outer jacket on 2-Conductor wires with an additional layer of insulation over the primary insulation.

The overwhelming variety and different constructions of 2-Conductor wires makes it difficult to list all of the possible diameter and center-to-center combinations of stripping blades Mechtrix offers to process these wires, so for specific recommendations please contact Mechtrix.

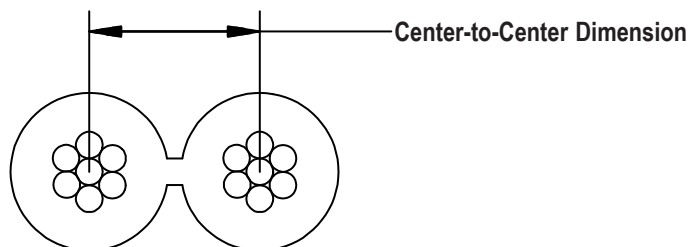

Due to the inherent problems associated with trying to accurately measure the center-to-center dimension of your particular wire, Mechtrix will perform a statistical dimensional analysis free of charge. To obtain an analysis of your wire, please send approximately 3 ft. of wire to Mechtrix. When completed Mechtrix will supply you with a Wire Data Report listing your wire data along with recommended part numbers and prices for all of the tooling required to process your wire.

Mechtrix 2-Conductor Stripping Blades are covered by U.S. Pat. 4,630,406 and U.S. Pat. 5,025,687



Mechtrix Corporation • W147 N9461 Held Drive • Menomonee Falls, WI 53051
Tel (262) 255-6555 • Fax (262) 255-2628 • www.mechtrix.com

Artos Tooling

Mechtrix Slitting Tools for Multi-Conductor Flat Cables

Used In These Machines

Artos

CS-6
CS-9
CS-10
CS-11
CS-15
CS-18
CS-20
TA-20
CS-21
CS-23
CS-26
CS-27
CS-29
CS-30
CS-33
S-1

Kut-Rite

MCS (all)
BTS (all)

The Mechtrix Slitting Tool System greatly improves the reliability of slitting 2 conductor cables by utilizing Mechtrix patented interlocking tooling design. This concept facilitates greater control over the cable both prior to and during slitting and thus achieves superior results.

All components are made of tool steel which has been hardened and ground to provide long tool life and precise component relationships. The system is a modular concept which allows the user to mix a number of different components together to customize the tooling for a particular cable.

To order slitting tools for a particular cable, please send a wire sample to Mechtrix. Mechtrix will size the cable and provide part numbers and prices.

The components illustrated are for slitting a 2-Conductor cable, slitting tools for 3, 4 and other multi-conductor cables are also available.

The tooling components and the function they perform are listed below:

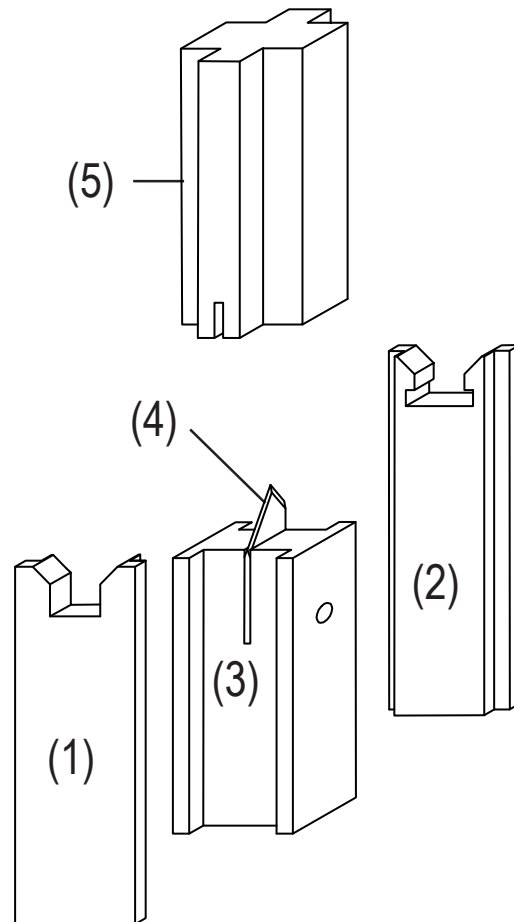

- (1) **SG-Slitting Guide** is designed to interlock with the SB-Slitting Blade Holder to guide the wire into the proper position for slitting.
- (2) **SGR-Slitting Guide w/Relief** is also designed to interlock with the SB-Slitting Blade Holder to guide the wire into the proper position for slitting. The relief in the bottom of the guide form provides room for the wire to expand after being slit, this reduces the chances of stretching the insulation after it has been slit.
- (3) **SB-Slitting Blade Holder** holds the SK-Slitting knife(s) on a pin without the use of screws, shims, or loose spacers. This system makes replacing slitting knives quick and simple.
- (4) **SK-Slitting Knives** are made out of high quality, heat-treated tool steel which greatly extends their life compared to standard spring steel slitting knives.
- (5) **SP-Slitting Pushers** are designed to push the wire into the slitting knife to a precise depth to insure the most efficient slit possible. The end of the pushers are polished to provide as smooth a surface as possible, allowing the wire to slide easily along their surface during the slitting process.

Mechtrix "Slitting Tools" are covered by U.S. Pat. 5,025,687

Artos Tooling

Mechtrix "PC" Series Stripping Blades for 3-Conductor Power Cords

Used In These Machines

Artos

CS-6
CS-9
CS-10
CS-11
CS-15
CS-18
CS-20
TA-20
CS-21
CS-23
CS-26
CS-27
CS-29
CS-30
CS-33
S-1

Kut-Rite

MCS (all)
BTS (all)

Mechtrix Stripping Blades for Flat Power Cords are truly unique.

Traditionally, SPT or HPN type wires have been processed using stripping blades whose cutting forms have been the same for all three conductors. To optimize process reliability and quality, it is critical that the blade designs recognize that different cutting forms are required to strip the outer conductors than are required to reliably strip the inner (separately insulated) conductor. Only Mechtrix Blades incorporate the cutting form geometries necessary to reliably strip all three conductors simultaneously.

The ability to produce special cutting forms has also enabled Mechtrix to offer blades to process virtually every wire end configuration required. These blades, combined with Mechtrix Accu-Set spacers, have enabled our customers to reliably process stagger strip configurations and difficult wire which were previously impossible to process automatically or relegated to bench or hand operations. (Please note that stagger strip configurations require the use of a pre-slitler).

"PC" Stripping Blades also require the use of "straight cut" cut-off blades for process optimization.

The overwhelming number of combinations and permutations of wire end configurations makes it difficult to list all of the possible diameter and center-to-center combinations of stripping blades Mechtrix offers to process these wires, so for specific recommendations please contact Mechtrix. To obtain detailed information regarding tooling recommended for your requirements, please send Mechtrix a sample of your wire along with a detailed drawing of the required wire end configurations.

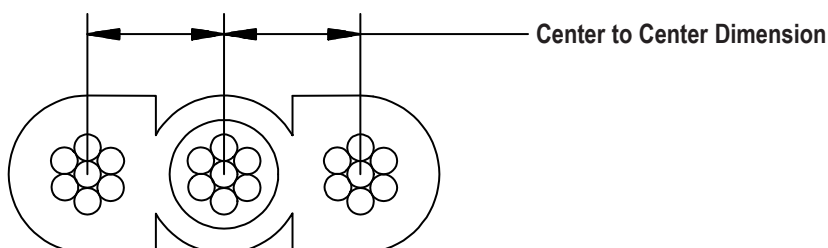
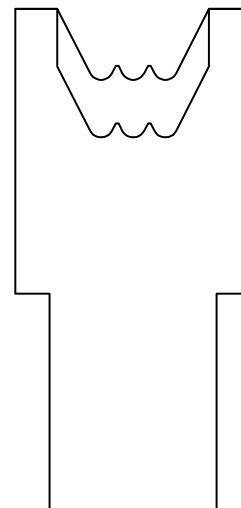

Due to the inherent problems associated with trying to accurately measure the center-to-center dimension of your particular wire, Mechtrix will perform a statistical dimensional analysis free of charge. To obtain an analysis of your wire, please send approximately 3 ft. of wire to Mechtrix. When completed Mechtrix will supply you with a Wire Data Report listing your wire data along with recommended part numbers and prices for all of the tooling required to process your wire.

Mechtrix "PC" Series Stripping Blades are covered by U.S. Pat. 4,630,406 and U.S. Pat. 5,025,687



Mechtrix Corporation • W147 N9461 Held Drive • Menomonee Falls, WI 53051
Tel (262) 255-6555 • Fax (262) 255-2628 • www.mechtrix.com

Artos Tooling

Mechtrix "PC" Series Stripping Blade Configurations

Used In These Machines

Artos

- CS-6
- CS-9
- CS-10
- CS-11
- CS-15
- CS-18
- CS-20
- TA-20
- CS-21
- CS-23
- CS-26
- CS-27
- CS-29
- CS-30
- CS-33
- S-1

Kut-Rite

- MCS (all)
- BTS (all)

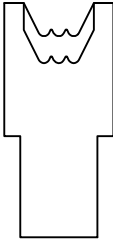
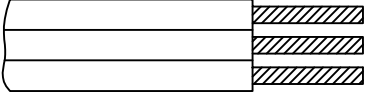
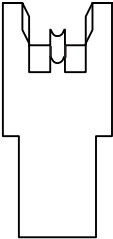
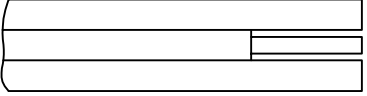
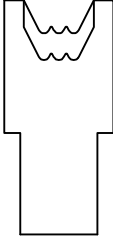
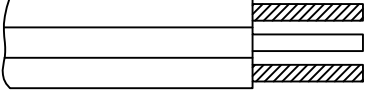
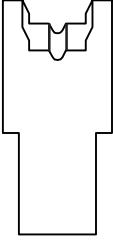
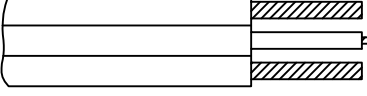
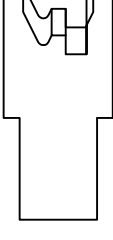
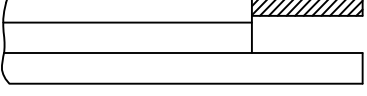
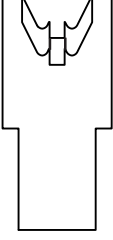
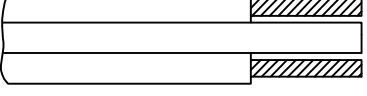
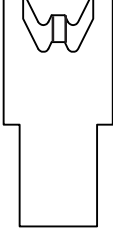
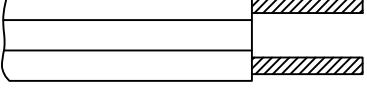
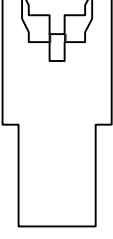
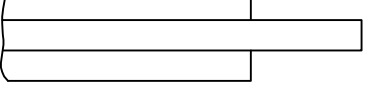
 <p>Strips all three conductors</p> 	 <p>De-webs bulk off of center ground</p> 
 <p>Strips outside conductors Strips bulk off green ground insulation</p> 	 <p>Cuts off two outside conductors Strips center ground conductor</p> 
 <p>Strips outside conductor Blunt cuts center Leaves outside conductor</p> 	 <p>Strips outside conductors Leaves center bulk</p> 
 <p>Strips outside conductors Blunt cuts center ground</p> 	 <p>Cuts bulk on outside Leaves center bulk</p> 

Artos Tooling

Mechtrix “Accu-Set” Spacers©

Used In These Machines

Artos

CS-6
CS-9
CS-10
CS-11
CS-15
CS-18
CS-20
TA-20
CS-21
CS-23
CS-27
CS-30
CS-33
S-1

Amp

CLS (all)

Kut-Rite

MCS (all)
BTS (all)

Accu-Set Spacers© were developed following a detailed study with regard to the effects of spacers (used in combination to achieve a desired strip length) on Strip Related Failures. The study, entitled “Spacer Analysis” (available upon request at no charge) clearly pointed to a variation in the thickness of the spacers (which are used to separate the cut-off and stripping blades in tooling set-ups) as a cause for improper meshing of blades (thus decreasing tool life and increasing the amount of force required to remove the slug of insulation from a wire) as well as increasing set-up times and substantially contributing to diminished process reliability.

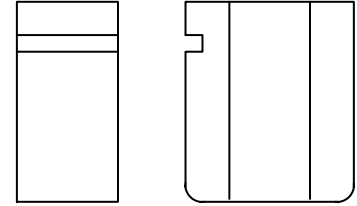

Accu-Set Spacers are thickness toleranced to +/- 0.0005" and are flat and parallel to +/- 0.0003".

Only one (1) Accu-Set Spacer need be used to obtain a desired strip length, thus diminishing set-up time and problems with potential tolerance stack-up which occur when a number of spacers must be used.

Tooling changes can be made more quickly because the Accu-Set Spacers incorporate a small slot at the top of the spacer which aids the efficient removal of the spacer from the tooling assembly.

Accu-Set Spacers are made of through-hardened steel, thus eliminating the development of burrs and facial flaws which affect the dimensional integrity of the spacer.

Accu-Set Spacers are available in both metric and inch sizes, with or without slots to accommodate the use of a knock-out for insulation slug removal.

Mechtrix “Accu-Set” Spacers© are covered by U.S. Pat. 4,784,024



Mechtrix Corporation • W147 N9461 Held Drive • Menomonee Falls, WI 53051
Tel (262) 255-6555 • Fax (262) 255-2628 • www.mechtrix.com

Artos Tooling

Mechtrix "Accu-Set" Spacers©

Used In These Machines

Artos

- CS-6
- CS-9
- CS-10
- CS-11
- CS-15
- CS-18
- CS-20
- TA-20
- CS-21
- CS-23
- CS-27
- CS-30
- CS-33
- S-1

Amp

CLS (all)

Kut-Rite

MCS (all)
BTS (all)

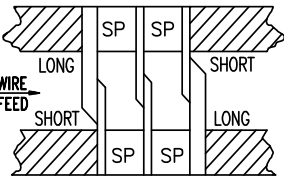
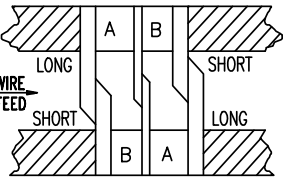
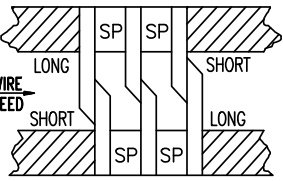
DESIRED STRIP LENGTH	USE THIS TABLE IF:	USE THIS TABLE IF:		USE THIS TABLE IF:
				
	-Cut-off Blades are both 1/16" thick -Short Strip Blades are 1/16" thick	-Cut-off Blades are both 1/16" thick -Short Strip Blades are 1/8" thick		-Cut-off Blades are both 1/8" thick -Short Strip Blades are 1/8" thick
	ORDER SPACER #	A	B	ORDER SPACER #
1/8"	AS-2	-	-	-
5/32"	AS-3	-	-	-
3/16"	AS-4	AS-4	AS-2	-
7/32"	AS-5	AS-5	AS-3	-
1/4"	AS-6	AS-6	AS-4	AS-4
9/32"	AS-7	AS-7	AS-5	AS-5
5/16"	AS-8	AS-8	AS-6	AS-6
11/32"	AS-9	AS-9	AS-7	AS-7
3/8"	AS-10	AS-10	AS-8	AS-8
13/32"	AS-11	AS-11	AS-9	AS-9
7/16"	AS-12	AS-12	AS-10	AS-10
15/32"	AS-13	AS-13	AS-11	AS-11
1/2"	AS-14	AS-14	AS-12	AS-12
17/32"	AS-15	AS-15	AS-13	AS-13
9/16"	AS-16	AS-16	AS-14	AS-14
19/32"	AS-17	AS-17	AS-15	AS-15
5/8"	AS-18	AS-18	AS-16	AS-16
21/32"	AS-19	AS-19	AS-17	AS-17
11/16"	AS-20	AS-20	AS-18	AS-18
23/32"	AS-21	AS-21	AS-19	AS-19
3/4"	AS-22	AS-22	AS-20	AS-20
25/32"	AS-23	AS-23	AS-21	AS-21
13/16"	AS-24	AS-24	AS-22	AS-22
27/32"	AS-25	AS-25	AS-23	AS-23
7/8"	AS-26	AS-26	AS-24	AS-24
29/32"	AS-27	AS-27	AS-25	AS-25
15/16"	AS-28	AS-28	AS-26	AS-26
31/32"	AS-29	AS-29	AS-27	AS-27
1"	AS-30	AS-30	AS-28	AS-28

To order spacers with knock-out slots, simply add the suffix "-S" to the above listed part number.

Mechtrix "Accu-Set" Spacers© are covered by U.S. Pat. 4,784,024



Mechtrix Corporation • W147 N9461 Held Drive • Menomonee Falls, WI 53051
Tel (262) 255-6555 • Fax (262) 255-2628 • www.mechtrix.com

Artos Tooling

Mechtrix "Accu-Set" Spacers©

Used In These
Machines

Artos

CS-6
CS-9
CS-10
CS-11
CS-15
CS-18
CS-20
TA-20
CS-21
CS-23
CS-27
CS-30
CS-33
S-1

Amp

CLS (all)

Kut-Rite

MCS (all)
BTS (all)

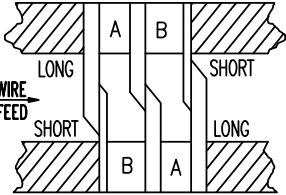
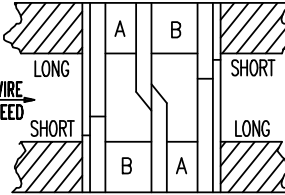
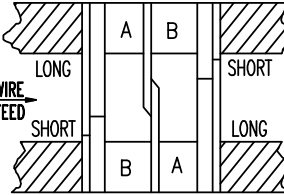
DESIRED STRIP LENGTH	USE THIS TABLE IF:		USE THIS TABLE IF:		USE THIS TABLE IF:	
	 <p>-Cut-off Blades are both 1/8" thick -Short Stripping Blades are 1/16" thick</p>		 <p>-Cut-off Blades are both 1/8" thick -"ID" Stripping Blades are used</p>		 <p>-Cut-off Blades are both 1/16" thick -"ID" Stripping Blades are used</p>	
	ORDER SPACER #		ORDER SPACER #		ORDER SPACER #	
	A	B	A	B	A	B
1/8"	-	-	-	-	AS-2	AS-4
5/32"	-	-	-	-	AS-3	AS-5
3/16"	AS-2	AS-4	AS-2	AS-6	AS-4	AS-6
7/32"	AS-3	AS-5	AS-3	AS-7	AS-5	AS-7
1/4"	AS-4	AS-6	AS-4	AS-8	AS-6	AS-8
9/32"	AS-5	AS-7	AS-5	AS-9	AS-7	AS-9
5/16"	AS-6	AS-8	AS-6	AS-10	AS-8	AS-10
11/32"	AS-7	AS-9	AS-7	AS-11	AS-9	AS-11
3/8"	AS-8	AS-10	AS-8	AS-12	AS-10	AS-12
13/32"	AS-9	AS-11	AS-9	AS-13	AS-11	AS-13
7/16"	AS-10	AS-12	AS-10	AS-14	AS-12	AS-14
15/32"	AS-11	AS-13	AS-11	AS-15	AS-13	AS-15
1/2"	AS-12	AS-14	AS-12	AS-16	AS-14	AS-16
17/32"	AS-13	AS-15	AS-13	AS-17	AS-15	AS-17
9/16"	AS-14	AS-16	AS-14	AS-18	AS-16	AS-18
19/32"	AS-15	AS-17	AS-15	AS-19	AS-17	AS-19
5/8"	AS-16	AS-18	AS-16	AS-20	AS-18	AS-20
21/32"	AS-17	AS-19	AS-17	AS-21	AS-19	AS-21
11/16"	AS-18	AS-20	AS-18	AS-22	AS-20	AS-22
23/32"	AS-19	AS-21	AS-19	AS-23	AS-21	AS-23
3/4"	AS-20	AS-22	AS-20	AS-24	AS-22	AS-24
25/32"	AS-21	AS-23	AS-21	AS-25	AS-23	AS-25
13/16"	AS-22	AS-24	AS-22	AS-26	AS-24	AS-26
27/32"	AS-23	AS-25	AS-23	AS-27	AS-25	AS-27
7/8"	AS-24	AS-26	AS-24	AS-28	AS-26	AS-28
29/32"	AS-25	AS-27	AS-25	AS-29	AS-27	AS-29
15/16"	AS-26	AS-28	AS-26	AS-30	AS-28	AS-30
31/32"	AS-27	AS-29	AS-27	AS-31	AS-29	AS-31
1"	AS-28	AS-30	AS-28	AS-32	AS-30	AS-32

To order spacers with knock-out slots, simply add the suffix "-S" to the above listed part number.

Mechtrix "Accu-Set" Spacers© are covered by U.S. Pat. 4,784,024



Mechtrix Corporation • W147 N9461 Held Drive • Menomonee Falls, WI 53051
Tel (262) 255-6555 • Fax (262) 255-2628 • www.mechtrix.com

Artos Tooling

Mechtrix "Accu-Set" Spacers©

Used In These Machines

Artos

- CS-6
- CS-9
- CS-10
- CS-11
- CS-15
- CS-18
- CS-20
- TA-20
- CS-21
- CS-23
- CS-27
- CS-30
- CS-33
- S-1

Amp

CLS (all)

Kut-Rite

- MCS (all)
- BTS (all)

DESIRED STRIP LENGTH	USE THIS TABLE IF:	USE THIS TABLE IF:		USE THIS TABLE IF:	
	-Cut-off Blades are both 1/16" thick -Short Strip Blades are 1/16" thick	-Cut-off Blades are both 1/16" thick -Short Strip Blades are 1/8" thick		-Cut-off Blades are both 1/8" thick -Short Strip Blades are 1/8" thick	
	ORDER SPACER #	ORDER SPACER #		ORDER SPACER #	
		A	B		
3.5mm	ASM-105	-	-	-	
4.0mm	ASM-107	-	-	-	
4.5mm	ASM-110	-	-	-	
5.0mm	ASM-113	ASM-113	ASM-104	-	
5.5mm	ASM-116	ASM-116	ASM-106	-	
6.0mm	ASM-119	ASM-119	ASM-109	-	
6.5mm	ASM-122	ASM-122	ASM-112	ASM-112	
7.0mm	ASM-125	ASM-125	ASM-115	ASM-115	
7.5mm	ASM-128	ASM-128	ASM-118	ASM-118	
8.0mm	ASM-131	ASM-131	ASM-121	ASM-121	
8.5mm	ASM-134	ASM-134	ASM-124	ASM-124	
9.0mm	ASM-137	ASM-137	ASM-127	ASM-127	
9.5mm	ASM-140	ASM-140	ASM-130	ASM-130	
10.0mm	ASM-143	ASM-143	ASM-133	ASM-133	
10.5mm	ASM-146	ASM-146	ASM-136	ASM-136	
11.0mm	ASM-149	ASM-149	ASM-139	ASM-139	
11.5mm	ASM-152	ASM-152	ASM-142	ASM-142	
12.0mm	ASM-155	ASM-155	ASM-145	ASM-145	
12.5mm	ASM-158	ASM-158	ASM-148	ASM-148	
13.0mm	ASM-161	ASM-161	ASM-151	ASM-151	
13.5mm	ASM-164	ASM-164	ASM-154	ASM-154	
14.0mm	ASM-167	ASM-167	ASM-157	ASM-157	
14.5mm	ASM-170	ASM-170	ASM-160	ASM-160	
15.0mm	ASM-173	ASM-173	ASM-163	ASM-163	
15.5mm	ASM-176	ASM-176	ASM-166	ASM-166	
16.0mm	ASM-179	ASM-179	ASM-169	ASM-169	
16.5mm	ASM-182	ASM-182	ASM-172	ASM-172	
17.0mm	ASM-185	ASM-185	ASM-175	ASM-175	
17.5mm	ASM-188	ASM-188	ASM-178	ASM-178	
18.0mm	ASM-191	ASM-191	ASM-181	ASM-181	
18.5mm	ASM-194	ASM-194	ASM-184	ASM-184	
19.0mm	ASM-197	ASM-197	ASM-187	ASM-187	
19.5mm	ASM-200	ASM-200	ASM-190	ASM-190	
20.0mm	ASM-203	ASM-203	ASM-193	ASM-193	
20.5mm	ASM-206	ASM-206	ASM-196	ASM-196	
21.0mm	ASM-209	ASM-209	ASM-199	ASM-199	
21.5mm	ASM-212	ASM-212	ASM-202	ASM-202	
22.0mm	ASM-215	ASM-215	ASM-205	ASM-205	
22.5mm	ASM-218	ASM-218	ASM-208	ASM-208	
23.0mm	ASM-221	ASM-221	ASM-211	ASM-211	
23.5mm	ASM-224	ASM-224	ASM-214	ASM-214	
24.0mm	ASM-226	ASM-226	ASM-217	ASM-217	
24.5mm	ASM-228	ASM-228	ASM-220	ASM-220	
25.0mm	ASM-230	ASM-230	ASM-223	ASM-223	

Mechtrix "Accu-Set" Spacers© are covered by U.S. Pat. 4,784,024



Mechtrix Corporation • W147 N9461 Held Drive • Menomonee Falls, WI 53051
Tel (262) 255-6555 • Fax (262) 255-2628 • www.mechtrix.com

Artos Tooling

Mechtrix "Accu-Set" Spacers©

Used In These Machines

Artos

- CS-6
- CS-9
- CS-10
- CS-11
- CS-15
- CS-18
- CS-20
- TA-20
- CS-21
- CS-23
- CS-27
- CS-30
- CS-33
- S-1

Amp

CLS (all)

Kut-Rite

- MCS (all)
- BTS (all)

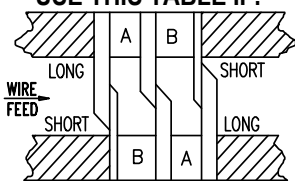
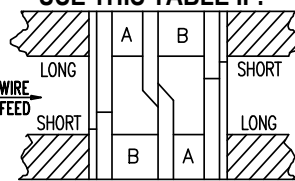
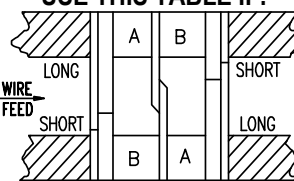
DESIRED STRIP LENGTH	USE THIS TABLE IF: 		USE THIS TABLE IF: 		USE THIS TABLE IF: 	
	-Cut-off Blades are both 1/8" thick -"Short" Strip Blades are 1/16" thick		-Cut-off Blades are both 1/8" thick -"ID" Stripping Blades are used		-Cut-off Blades are both 1/16" thick -"ID" Stripping Blades are used	
	ORDER SPACER #		ORDER SPACER #		ORDER SPACER #	
	A	B	A	B	A	B
3.5mm	-	-	-	-	ASM-105	ASM-114
4.0mm	-	-	-	-	ASM-107	ASM-117
4.5mm	-	-	-	-	ASM-110	ASM-120
5.0mm	ASM-104	ASM-113	ASM-104	ASM-123	ASM-113	ASM-123
5.5mm	ASM-106	ASM-116	ASM-106	ASM-126	ASM-116	ASM-126
6.0mm	ASM-109	ASM-119	ASM-109	ASM-129	ASM-119	ASM-129
6.5mm	ASM-112	ASM-122	ASM-112	ASM-132	ASM-122	ASM-132
7.0mm	ASM-115	ASM-125	ASM-115	ASM-135	ASM-125	ASM-135
7.5mm	ASM-118	ASM-128	ASM-118	ASM-138	ASM-128	ASM-138
8.0mm	ASM-121	ASM-131	ASM-121	ASM-141	ASM-131	ASM-141
8.5mm	ASM-124	ASM-134	ASM-124	ASM-144	ASM-134	ASM-144
9.0mm	ASM-127	ASM-137	ASM-127	ASM-147	ASM-137	ASM-147
9.5mm	ASM-130	ASM-140	ASM-130	ASM-150	ASM-140	ASM-150
10.0mm	ASM-133	ASM-143	ASM-133	ASM-153	ASM-143	ASM-153
10.5mm	ASM-136	ASM-146	ASM-136	ASM-156	ASM-146	ASM-156
11.0mm	ASM-139	ASM-149	ASM-139	ASM-159	ASM-149	ASM-159
11.5mm	ASM-142	ASM-152	ASM-142	ASM-162	ASM-152	ASM-162
12.0mm	ASM-145	ASM-155	ASM-145	ASM-165	ASM-155	ASM-165
12.5mm	ASM-148	ASM-158	ASM-148	ASM-168	ASM-158	ASM-168
13.0mm	ASM-151	ASM-161	ASM-151	ASM-171	ASM-161	ASM-171
13.5mm	ASM-154	ASM-164	ASM-154	ASM-174	ASM-164	ASM-174
14.0mm	ASM-157	ASM-167	ASM-157	ASM-177	ASM-167	ASM-177
14.5mm	ASM-160	ASM-170	ASM-160	ASM-180	ASM-170	ASM-180
15.0mm	ASM-163	ASM-173	ASM-163	ASM-183	ASM-173	ASM-183
15.5mm	ASM-166	ASM-176	ASM-166	ASM-186	ASM-176	ASM-186
16.0mm	ASM-169	ASM-179	ASM-169	ASM-189	ASM-179	ASM-189
16.5mm	ASM-172	ASM-182	ASM-172	ASM-192	ASM-182	ASM-192
17.0mm	ASM-175	ASM-185	ASM-175	ASM-195	ASM-185	ASM-195
17.5mm	ASM-178	ASM-188	ASM-178	ASM-198	ASM-188	ASM-198
18.0mm	ASM-181	ASM-191	ASM-181	ASM-201	ASM-191	ASM-201
18.5mm	ASM-184	ASM-194	ASM-184	ASM-204	ASM-194	ASM-204
19.0mm	ASM-187	ASM-197	ASM-187	ASM-207	ASM-197	ASM-207
19.5mm	ASM-190	ASM-200	ASM-190	ASM-210	ASM-200	ASM-210
20.0mm	ASM-193	ASM-203	ASM-193	ASM-213	ASM-203	ASM-213
20.5mm	ASM-196	ASM-206	ASM-196	ASM-216	ASM-206	ASM-216
21.0mm	ASM-199	ASM-209	ASM-199	ASM-219	ASM-209	ASM-219
21.5mm	ASM-202	ASM-212	ASM-202	ASM-222	ASM-212	ASM-222
22.0mm	ASM-205	ASM-215	ASM-205	ASM-225	ASM-215	ASM-225
22.5mm	ASM-208	ASM-218	ASM-208	ASM-227	ASM-218	ASM-227
23.0mm	ASM-211	ASM-221	ASM-211	ASM-229	ASM-221	ASM-229
23.5mm	ASM-214	ASM-224	ASM-214	ASM-231	ASM-224	ASM-231
24.0mm	ASM-217	ASM-226	ASM-217	ASM-232	ASM-226	ASM-232
24.5mm	ASM-220	ASM-228	ASM-220	ASM-233	ASM-228	ASM-233
25.0mm	ASM-223	ASM-230	ASM-223	ASM-234	ASM-230	ASM-234

Mechtrix "Accu-Set" Spacers© are covered by U.S. Pat. 4,784,024



Mechtrix Corporation • W147 N9461 Held Drive • Menomonee Falls, WI 53051
Tel (262) 255-6555 • Fax (262) 255-2628 • www.mechtrix.com

Artos Tooling

Artos Toolholders

Used In These Machines

Artos

- CS-6
- CS-9
- CS-10
- CS-11
- CS-15
- CS-18
- CS-20
- TA-20
- CS-21
- CS-23
- CS-27
- CS-30
- CS-33
- S-1

Mechtrix offers the standard array of toolholders for most of the Artos Wire Processing Machines. We do not manufacture the toolholders but, we qualify the toolholders we sell to insure that they are functionally correct.

and add our unique end screw/washer component that eliminates the possibility of the washer falling out of the toolholder screw.

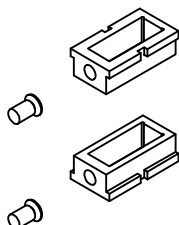

Artos 2" Toolholders with Mechtrix End Screw/Washer Assembly

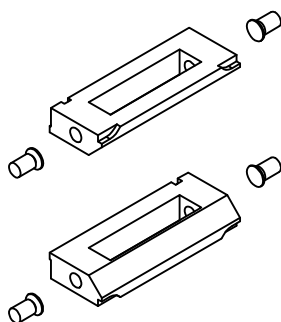

Artos 4" Toolholders with Mechtrix End Screw/Washer Assembly

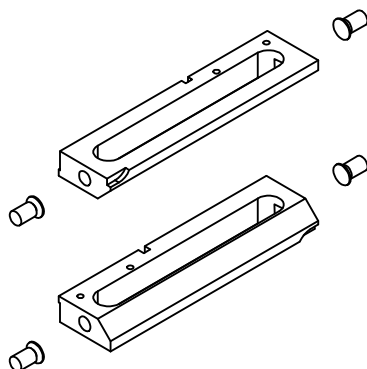

Artos 6" Toolholders with Mechtrix End Screw/Washer Assembly

Artos Toolholders Available thru Mechtrix

Mechtrix Description	Mechtrix Part Number	Blade Form Diameter		OEM Part Number
		(in)	(mm)	
Artos 2" Toolholder w/#2515 End Screw (ea.)	08422-500	-	-	AH-1615-500
Artos 4" Toolholder w/#2515 End Screw (ea.)	07578-500	-	-	H-2527
Artos 6" Toolholder w/#2515 End Screw (set)	07579-500	-	-	AH-2761-500
Artos 8" Toolholder w/#2515 End Screw (set)	07580-500	-	-	AH-2762-500
CS-27 6" Toolholder w/#2515 End Screw (ea.)	13648-500	-	-	81299-1
CS-27 8" Toolholder w/#2515 End Screw (ea.)	13649-500	-	-	81299-2
End Screw/Washer Assembly	02515-500	-	-	-
Shear Head Screws	01129	-	-	-

